



狂刀出鞘，銳不可擋



泉發車刀礦油公司  
**CUTOL**  
CHUAN FA CUTTING TOOL CO., LTD.



機械零件  
Mechanical engineering



電子通訊  
Electronics industry



醫療工具  
Medical technology



航太工業  
Aerospace



汽車產業  
Automotive industry



專業客製  
Customization



# 目錄 CONTENTS

Page

內孔修刀系列 AcutoL MTR Boring-Series		1
內孔修刀系列 AcutoL MPR Profiling and Boring-with Series		2
內孔修刀系列 AcutoL MQR Profiling and Boring		3
內孔修刀系列 AcutoL MUR Profiling ,90° Face Cutting		4
內孔插溝刀系列 AcutoL MGR Grooving		5
內孔圓頭插溝刀系列 AcutoL MKR Full Radius Grooving		6
內孔端面插溝刀系列 AcutoL MFR Face Grooving		7
內孔端面圓頭插溝刀系列 AcutoL MZR Face Grooving		8
內孔牙刀系列 AcutoL MIR Threading		9
內孔倒拉刀系列 AcutoL MXR Back Turning		10
AcutoL - 刀桿套筒 Tiny Tools Bar Holders		11
AcutoL - 水平鎖固套筒 Tiny Tools Bar Holders		12
AcutoL - 斜向鎖固套筒 Tiny Tools Bar Holders		13

**Tiny Tools**

內孔修刀系列 AcutoL MTR  
Boring-Series

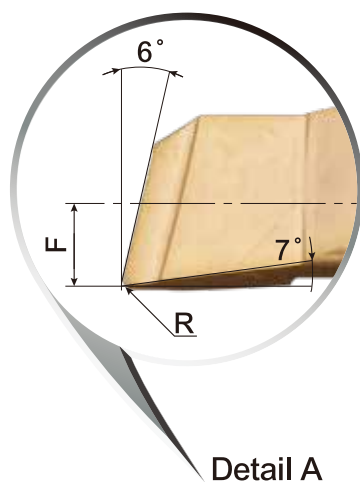
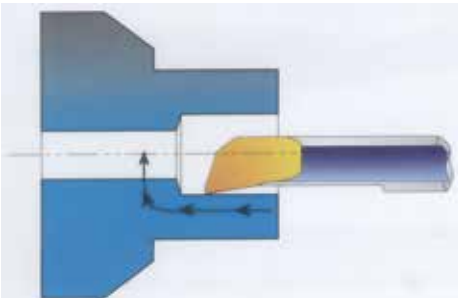
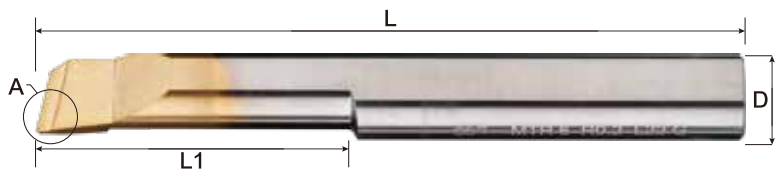

Detail A

產品規格	F	L1	L	R	D	最小加工徑
AcutoL MTR 3 R0.05 L10	1.3	10	50	0.05	3	3.0
AcutoL MTR 3 R0.05 L15	1.3	15	50	0.05	3	3.0
AcutoL MTR 3 R0.2 L15	1.3	15	50	0.2	3	3.0
AcutoL MTR 4 R0.2 L15	1.7	15	50	0.2	4	4.0
AcutoL MTR 4 R0.1 L22	1.7	22	50	0.1	4	4.0
AcutoL MTR 4 R0.2 L22	1.7	22	50	0.2	4	4.0
AcutoL MTR 5 R0.2 L15	2.1	15	50	0.2	5	5.0
AcutoL MTR 5 R0.2 L22	2.1	22	50	0.2	5	5.0
AcutoL MTR 6 R0.2 L22	2.8	22	50	0.2	6	6.0

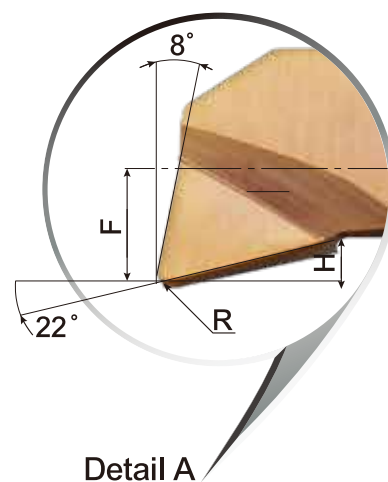
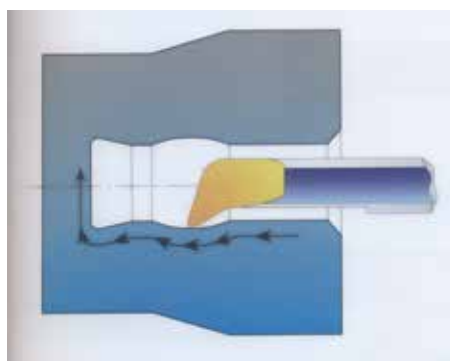
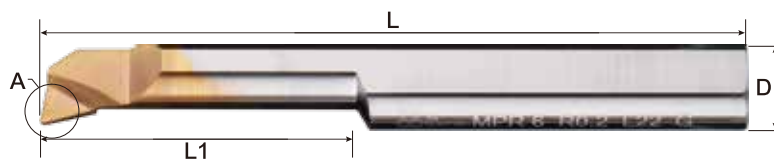

產品規格	F	L1	L	R	H	D	最小加工徑
AcutoL MPR 3 R0.2 L15	1.3	15	50	0.2	0.7	3	3.0
AcutoL MPR 4 R0.2 L15	1.7	15	50	0.2	0.8	4	4.0
AcutoL MPR 4 R0.2 L22	1.7	22	50	0.2	0.8	4	4.0
AcutoL MPR 5 R0.2 L15	2.1	15	50	0.2	1.2	5	5.0
AcutoL MPR 5 R0.2 L22	2.1	22	50	0.2	1.2	5	5.0
AcutoL MPR 6 R0.2 L22	2.8	22	50	0.2	1.4	6	6.0

**Tiny Tools**

內孔修刀系列 AcutoL MQR  
Profiling and Boring

**ACUTO L**  
**MQR**

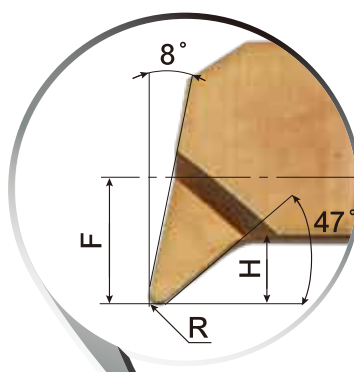
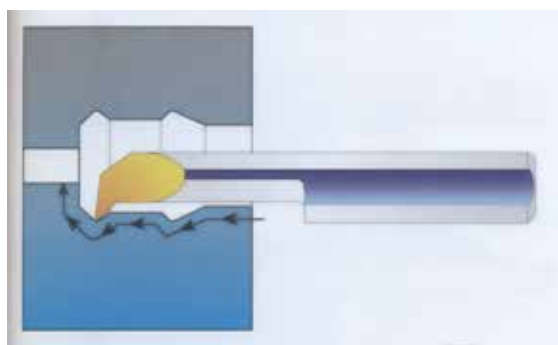
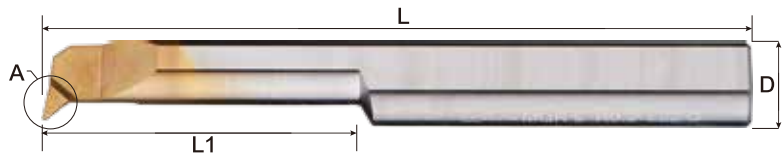

Detail A

產品規格	F	L1	L	R	H	D	最小加工徑
AcutoL MQR 3 R0.05 L15	1.4	15	50	0.05	0.7	3	3.0
AcutoL MQR 3 R0.2 L15	1.4	15	50	0.2	0.7	3	3.0
AcutoL MQR 4 R0.2 L15	1.8	15	50	0.2	0.8	4	4.0
AcutoL MQR 4 R0.2 L22	1.8	22	50	0.2	0.8	4	4.0
AcutoL MQR 5 R0.2 L15	2.3	15	50	0.2	1.3	5	5.0
AcutoL MQR 5 R0.2 L22	2.3	22	50	0.2	1.3	5	5.0
AcutoL MQR 6 R0.2 L22	2.8	22	50	0.2	1.4	6	6.0
AcutoL MQR 6 R0.4 L15	2.8	15	50	0.4	1.4	6	6.0
AcutoL MQR 6 R0.4 L22	2.8	22	50	0.4	1.4	6	6.0

Tiny Tools

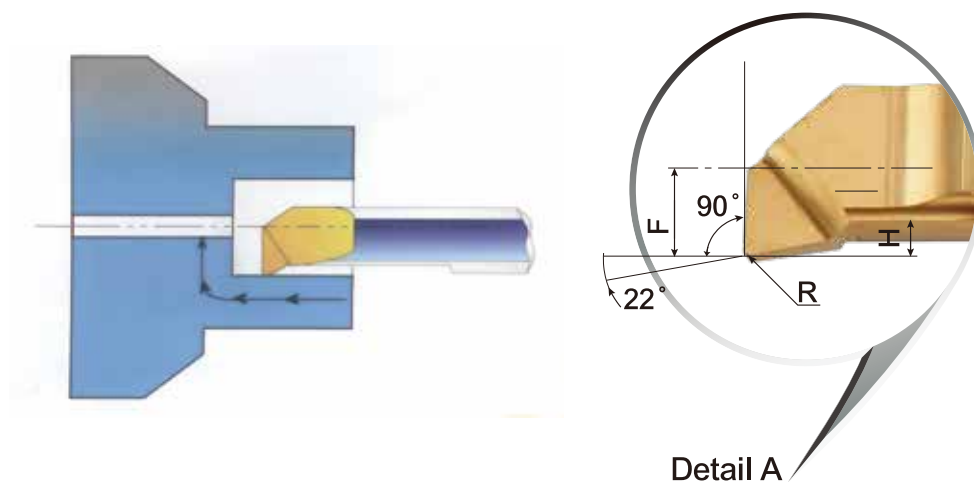
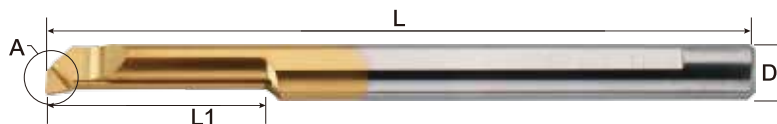

產品規格	F	L1	L	H	R	D	最小加工徑
AcutoL MUR 3 R0.05 L15	1.3	15	50	0.4	0.05	3	3.0
AcutoL MUR 4 R0.1 L15	1.7	15	50	0.5	0.1	4	4.0
AcutoL MUR 5 R0.15 L15	2.1	15	50	0.7	0.15	5	5.0

Tiny Tools

內孔插溝刀系列 AcutoL MGR  
Grooving

ACUTOL  
MGR

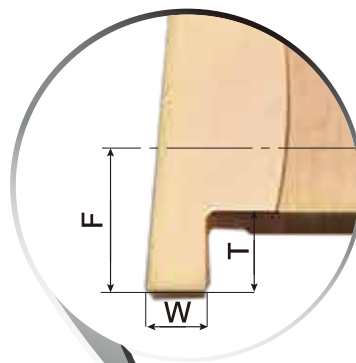
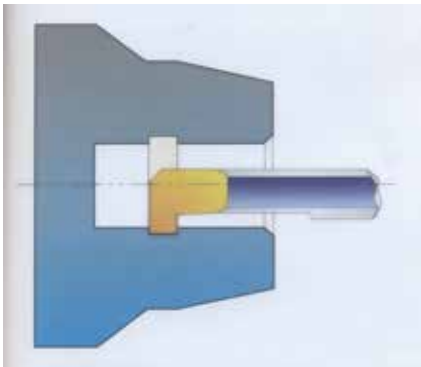

Detail A

Tiny Tools

產品規格	F	L1	L	W	T	D	最小加工徑
AcutoL MGR 4 B1.0 L10	1.7	10	50	1.0	1.0	4	4.0
AcutoL MGR 4 B1.5 L10	1.7	10	50	1.5	1.0	4	4.0
AcutoL MGR 5 B1.0 L15	2.3	15	50	1.0	1.5	5	5.0
AcutoL MGR 5 B2.0 L15	2.3	15	50	2.0	2.0	5	5.0
AcutoL MGR 6 B1.0 L15	2.8	15	50	1.0	1.5	6	6.0
AcutoL MGR 6 B2.0 L15	2.8	15	50	2.0	2.0	6	6.0



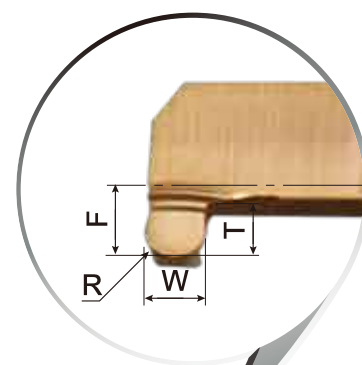
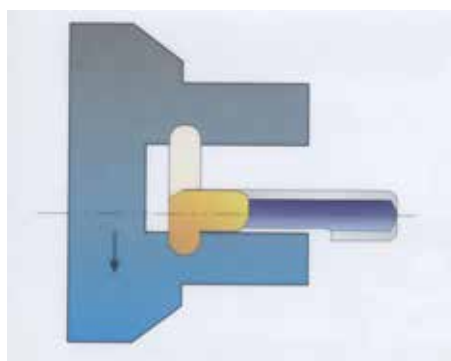
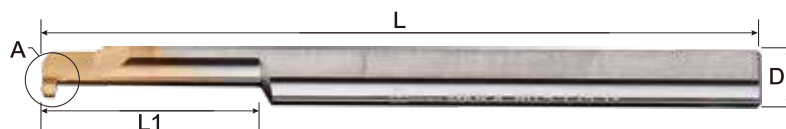

Detail A

產品規格	F	L1	L	W	T	R	D	最小加工徑
AcutoL MKR 4 B1.0 R0.5 L15	1.7	15	50	1.0	1.0	0.5	4	4.0
AcutoL MKR 5 B1.0 R0.5 L15	2.3	15	50	1.0	1.2	0.5	5	5.0
AcutoL MKR 5 B1.5 R0.75 L15	2.3	15	50	1.5	1.2	0.75	5	5.0
AcutoL MKR 6 B1.0 R0.5 L15	2.8	15	50	1.0	1.6	0.5	6	6.0
AcutoL MKR 6 B1.5 R0.75 L15	2.8	15	50	1.5	1.6	0.75	6	6.0

## Tiny Tools

### 內孔端面插溝刀系列 AcutoL MFR Face Grooving

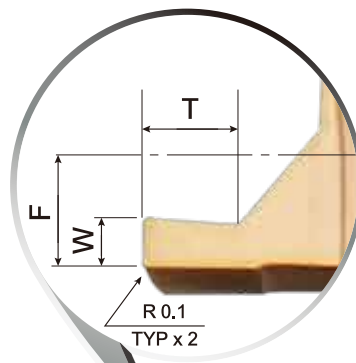
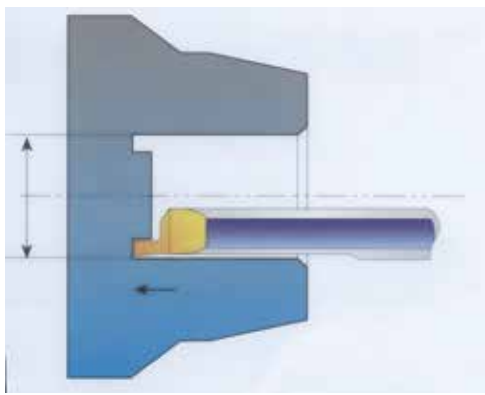
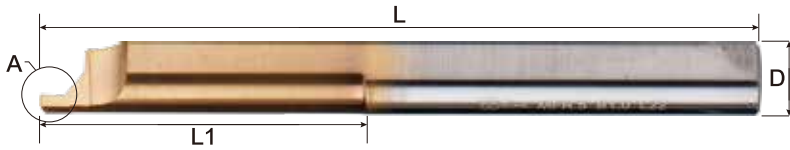

Detail A

產品規格	F	L1	L	W	T	D	最小加工徑
AcutoL MFR 4 B1.0 L15	1.9	15	50	1.0	1.5	4	4.0
AcutoL MFR 5 B1.0 L22	2.4	22	50	1.0	1.5	5	5.0
AcutoL MFR 5 B1.5 L22	2.4	22	50	1.5	2.5	5	5.0
AcutoL MFR 6 B1.0 L22	2.9	22	50	1.0	1.5	6	6.0
AcutoL MFR 6 B2.0 L22	2.9	22	50	2.0	3.0	6	6.0

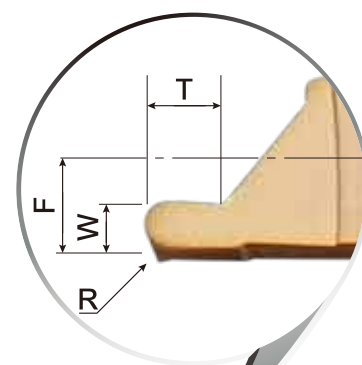
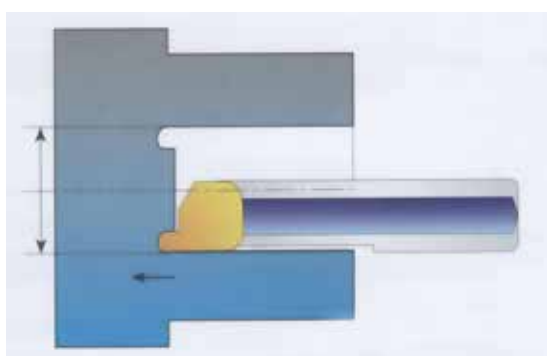
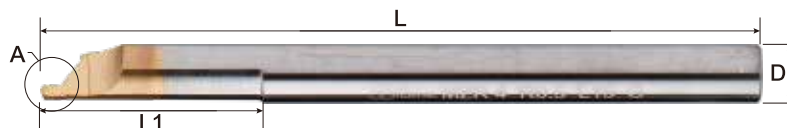

Detail A

產品規格	F	L1	L	W	T	R	D	最小加工徑
AcutoL MZR 4 R0.5 L15	1.9	15	50	1.0	1.2	0.5	4	4.0
AcutoL MZR 4 R0.75 L15	1.9	15	50	1.5	1.5	0.75	4	4.0
AcutoL MZR 5 R0.5 L22	2.4	22	50	1.0	1.2	0.5	5	5.0
AcutoL MZR 5 R0.75 L22	2.4	22	50	1.5	1.5	0.75	5	5.0
AcutoL MZR 6 R0.5 L22	2.9	22	50	1.0	1.2	0.5	6	6.0
AcutoL MZR 6 R0.75 L22	2.9	22	50	1.5	1.5	0.75	6	6.0

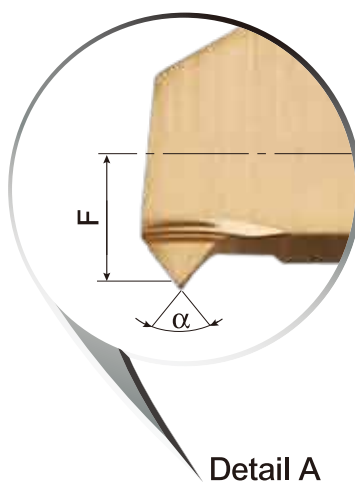
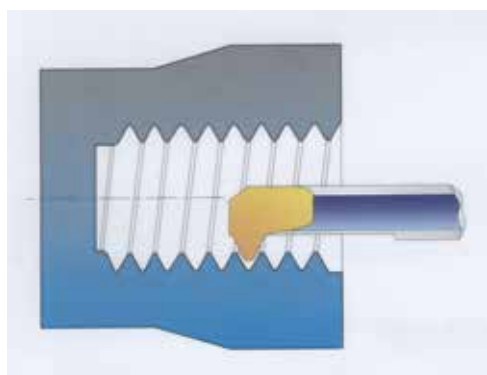
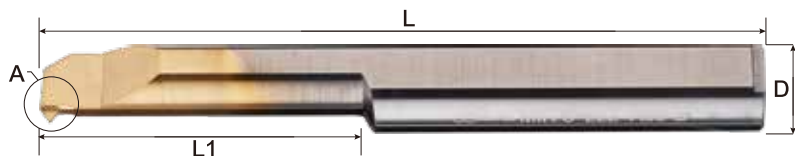

產品規格	F	L1	L	螺距		$\alpha$	D	最小加工徑
				mm	TPI			
AcutoL MIR 3 L15 A60	1.4	15	50	0.7-1.0	32-24	60	3	3.0
AcutoL MIR 3 L15 A55	1.4	15	50	0.5-1.0	48-24	55	3	3.0
AcutoL MIR 4 L15 A60	1.8	15	50	0.8-1.0	32-24	60	4	4.0
AcutoL MIR 4 L15 A55	1.8	15	50	0.5-1.0	48-24	55	4	4.0
AcutoL MIR 5 L22 A60	2.3	22	50	1.0-1.25	24-20	60	5	5.0
AcutoL MIR 5 L22 A55	2.3	22	50	0.5-1.25	48-20	55	5	5.0
AcutoL MIR 6 L22 A60	2.6	22	50	1.0-1.5	24-16	60	6	6.0
AcutoL MIR 6 L22 A55	2.6	22	50	0.5-1.5	48-16	55	6	6.0

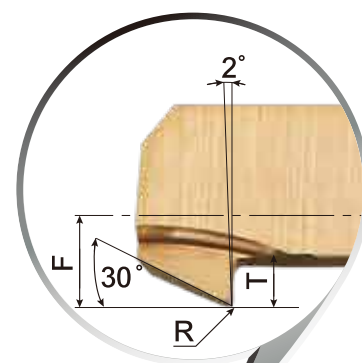
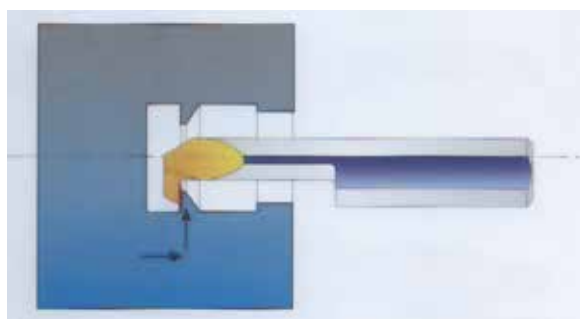
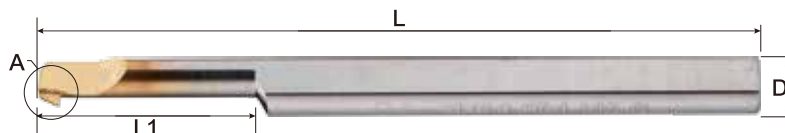

Detail A

產品規格	F	L1	L	W	T	R	D	最小加工徑
AcutoL MXR 4 R0.1 L15	1.3	15	50	1.5	0.8	0.1	4	4.0
AcutoL MXR 5 R0.2 L22	2.2	22	50	1.5	1.0	0.2	5	5.0
AcutoL MXR 6 R0.2 L22	2.8	22	50	1.5	1.8	0.2	6	6.0

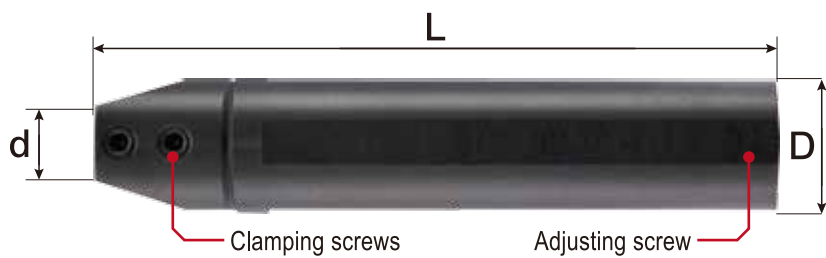

產品規格	L 套筒全長	D 套筒外徑	d 套筒內徑
AcutoL1905-03-95	95	19.05	3.0
AcutoL1905-04-95	95	19.05	4.0
AcutoL1905-05-95	95	19.05	5.0
AcutoL1905-06-95	95	19.05	6.0
AcutoL1920-03-100	100	20	3.0
AcutoL1920-04-100	100	20	4.0
AcutoL1920-05-100	100	20	5.0
AcutoL1920-06-100	100	20	6.0
AcutoL1922-03-110	110	22	3.0
AcutoL1922-04-110	110	22	4.0
AcutoL1922-05-110	110	22	5.0
AcutoL1922-06-110	110	22	6.0
AcutoL1923-03-110	110	23	3.0
AcutoL1923-04-110	110	23	4.0
AcutoL1923-05-110	110	23	5.0
AcutoL1923-06-110	110	23	6.0



產品規格	L 套筒全長	D 套筒外徑	d 套筒內徑
AcutoL NE-220343	43	22	3.0
AcutoL NE-220443	43	22	4.0
AcutoL NE-220543	43	22	5.0
AcutoL NE-220643	43	22	6.0

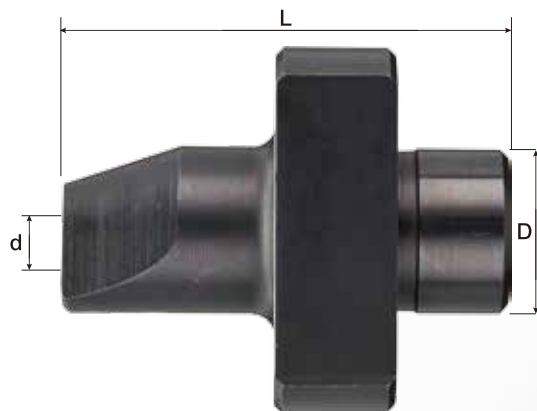

產品規格	L 套筒全長	D 套筒外徑	d 套筒內徑
AcutoL MA-220359	59	22	3.0
AcutoL MA-220459	59	22	4.0
AcutoL MA-220559	59	22	5.0
AcutoL MA-220659	59	22	6.0



MEMO





無膽勿試，非誠勿擾

[www.chuan-fa.com.tw](http://www.chuan-fa.com.tw)

1 獨特的不等分螺旋角設計，大幅增加銑削的穩定性

2 獨特的螺旋角設計和良好的拋光處理，大幅降低加工時的振動，並提升刀具的使用壽命

3 刀刃徑向軸的良好設計，有助於排屑的順暢性，以期達成加工面垂直度的要求

4 高效率的加工條件下，可達成加工件尺寸穩定和抑制毛邊產生的效果

獨特不等分割刃的設計

兼顧銳利度與抗崩刃性

大幅降低切削阻力

大幅抑制振動



泉發車刀礦油公司

新北市新莊區化成路287號  
TEL:(02)8521-1234 · (02)8521-1034  
FAX:(02)8522-0650 · (02)8521-1236

Mobile:0928100167  
E-mail:LK37@ms16.hinet.net  
公司網址:[www.chuan-fa.com.tw](http://www.chuan-fa.com.tw)

